

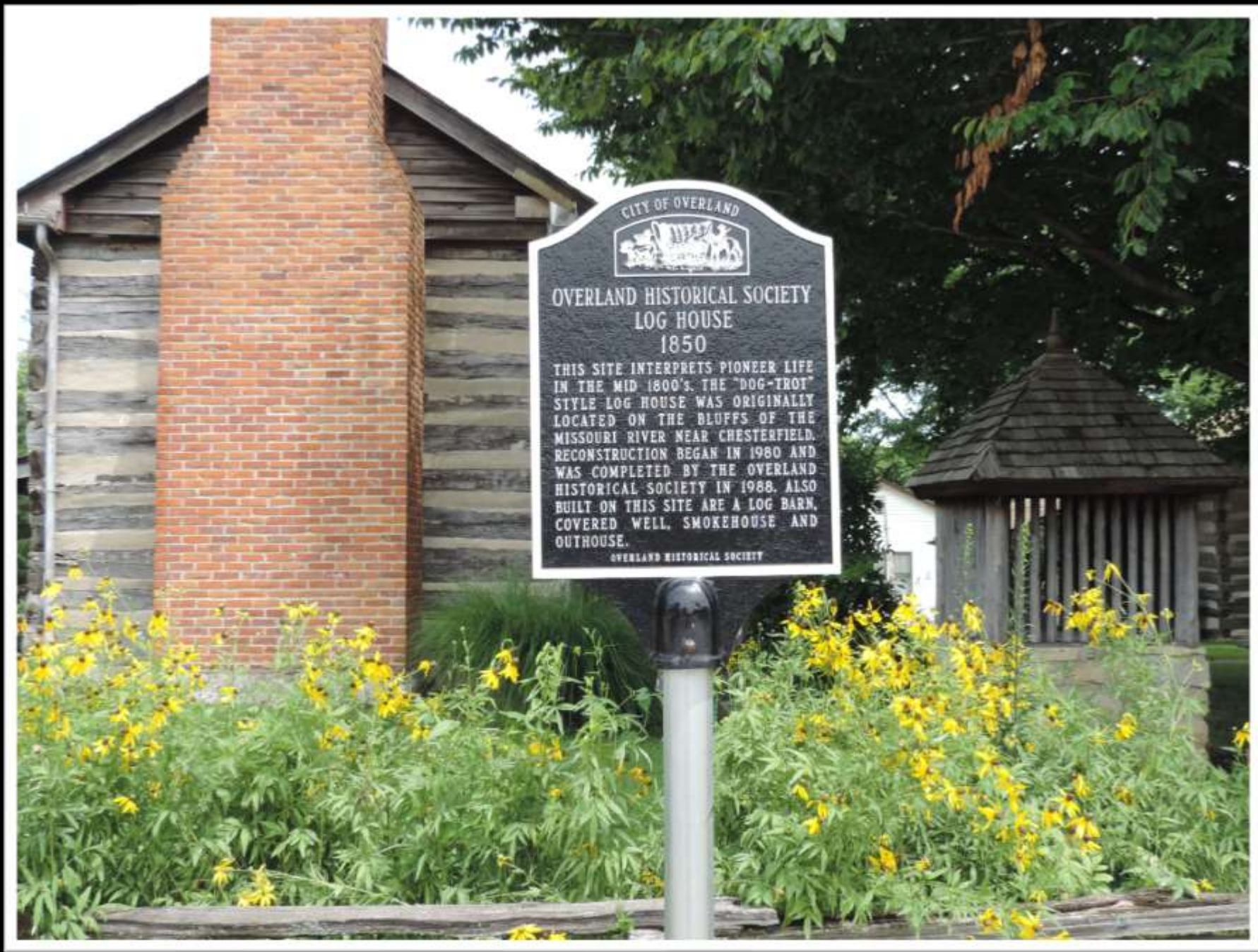

NATIVE PLANTS, NATURAL LANDSCAPES

ST. LOUIS CHAPTER





CITY OF OVERLAND



OVERLAND HISTORICAL SOCIETY
LOG HOUSE
1850

THIS SITE INTERPRETS PIONEER LIFE IN THE MID 1800'S. THE "DOG-TROT" STYLE LOG HOUSE WAS ORIGINALLY LOCATED ON THE BLUFFS OF THE MISSOURI RIVER NEAR CHESTERFIELD. RECONSTRUCTION BEGAN IN 1980 AND WAS COMPLETED BY THE OVERLAND HISTORICAL SOCIETY IN 1988. ALSO BUILT ON THIS SITE ARE A LOG BARN, COVERED WELL, SMOKEHOUSE AND OUTHOUSE.

OVERLAND HISTORICAL SOCIETY











Did you know?

*Our Chapter
has 180 members!*



Chris Kirmaier



Wild Ones
\$5.00 / plant
\$7.00 / tree and shrubs

ALICE WATT

CHERRY





2006 Landscape Challenge - Jacobs Family







A BIG thank you to our
20th Anniversary Planning Committee

Prem Barton

Pat Borgwald

Susan Burk

Susan Orr

Linda Tatum













Sherri DeRousse



**PRAIRIE
RESTORATION
AREA**



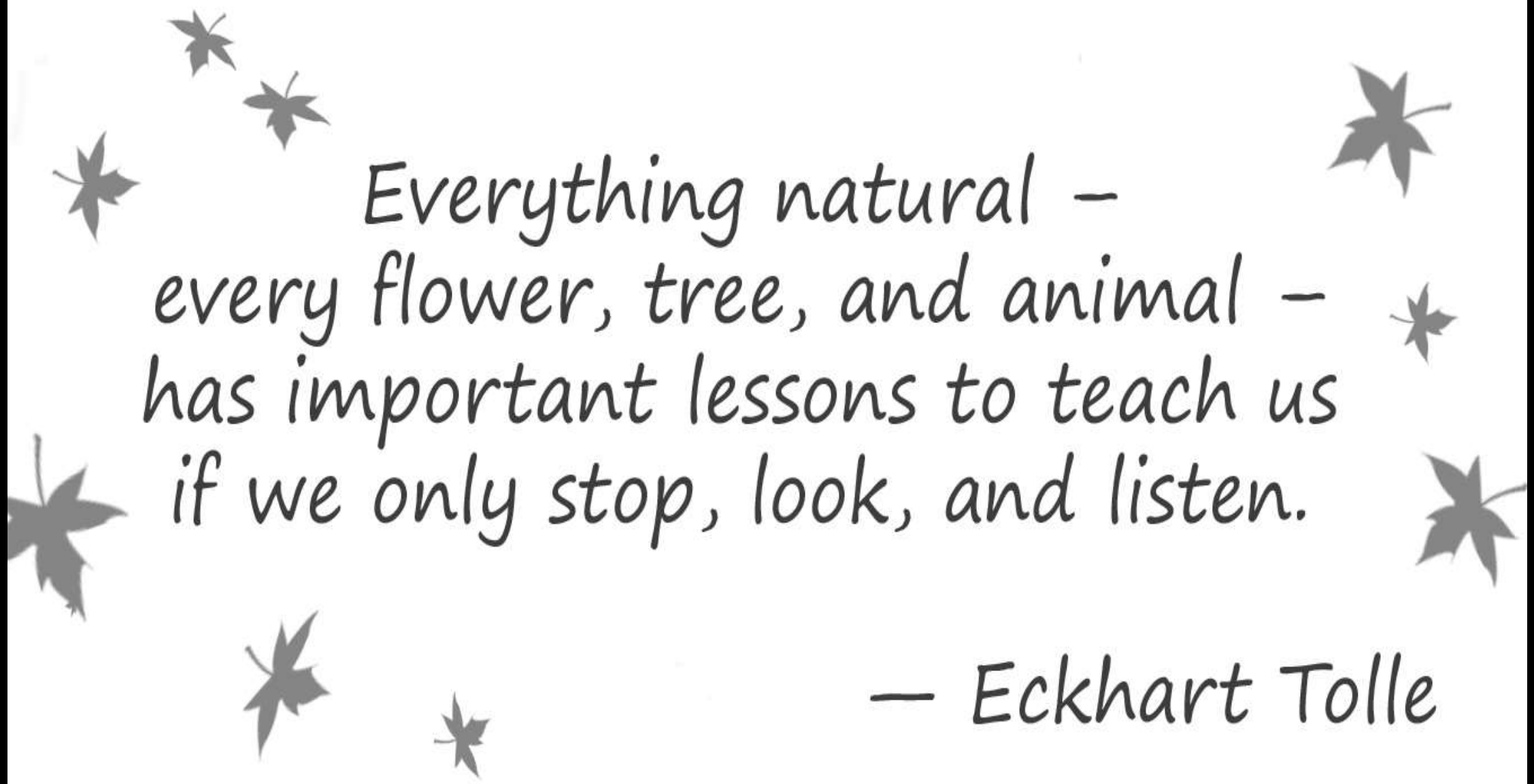

Everything natural –
every flower, tree, and animal –
has important lessons to teach us
if we only stop, look, and listen.

— Eckhart Tolle





2007 Landscape Challenge - Habitat for Humanity





2016 St. Louis Native Plant Garden Tour



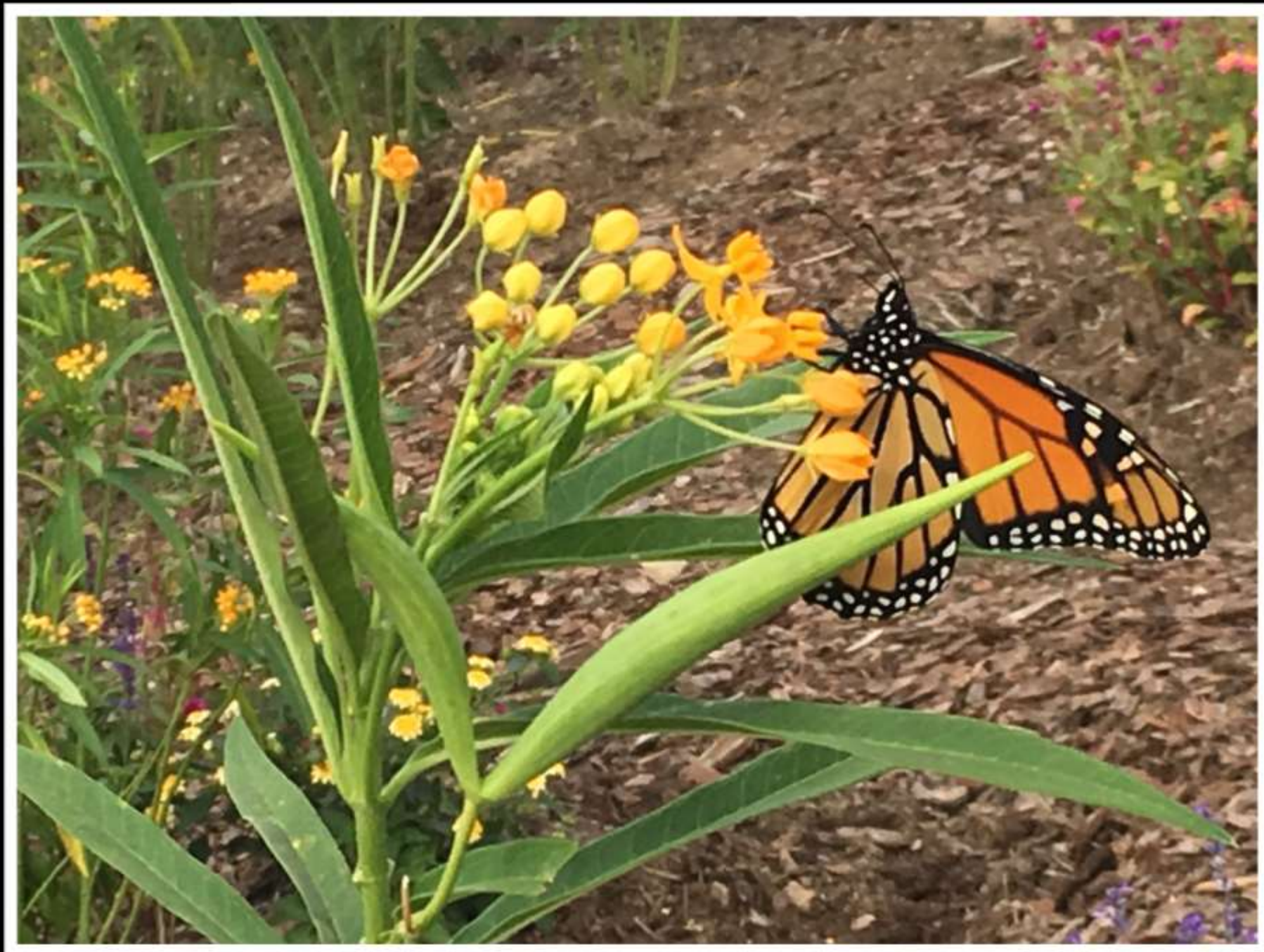





Wild Ones

Wild Ones -- St. Louis

Wild Ones Natural Landscapers Ltd. – St. Louis Chapter

P. O. Box 38, Gray Summit, Missouri 63039

Volume I, Number 1

Fall 1999







Kevin Mowery







2008 Landscape Challenge - Mary Lamb









2009 Landscape Challenge - Baum Family













Did you know?

*In 2018
our Speakers Bureau reached
more than 700 attendees
at 30+ events?*





























Landscape Challenge 2013 Dawn Weber



Did you know?



*Our Facebook page
has 778 likes!*



*If you use Facebook
please like our page
and share our posts*





© 2017 Dawn Weber







NATIVE PLANTS, NATURAL LANDSCAPES









2010 Landscape Challenge - Giunta Family

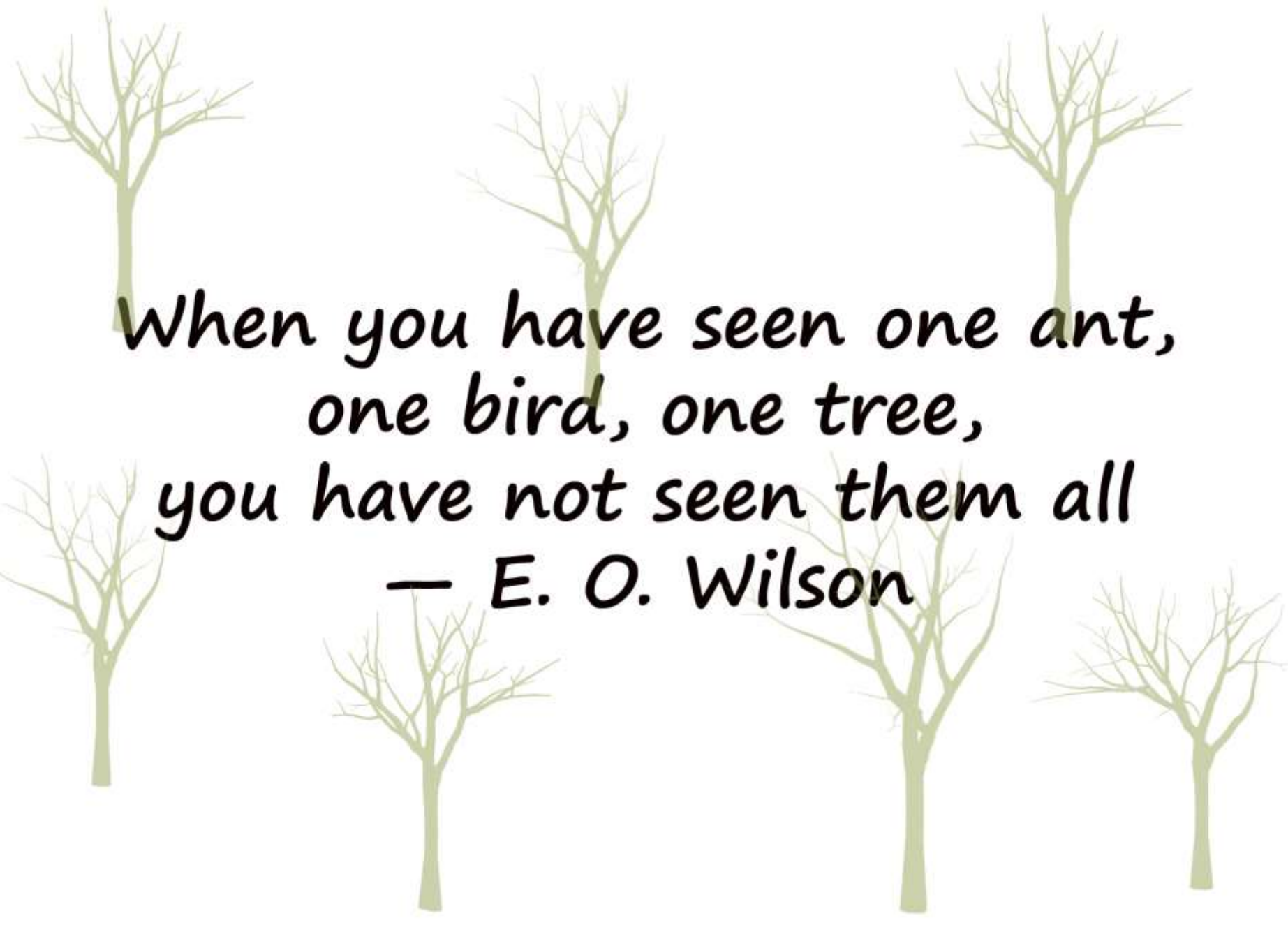

*When you have seen one ant,
one bird, one tree,
you have not seen them all
— E. O. Wilson*







Overwintering habitat is degraded by:

- Illegal logging
- Climate change
- Higher temperatures in Mexico stressing fir trees
- *Scolytus* beetles attacking stressed Oyamel fir trees
- Mexico's Monarch Reserve
- Harsh winter storms that can kill monarchs







Did you know?

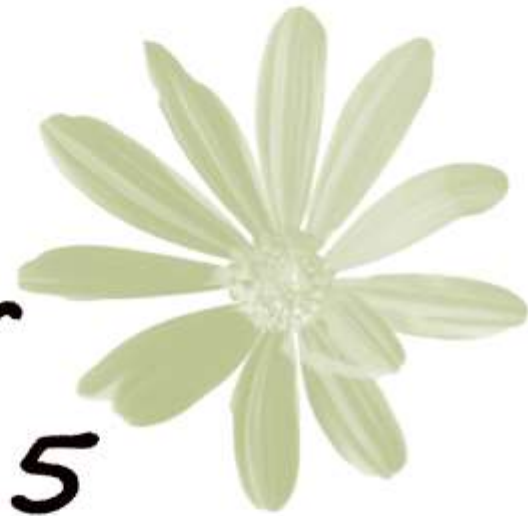

Our Chapter
earned \$4,495
selling plants at the
Spring Wildflower Market















2011 Landscape Challenge Rose Family







Garden
as if
life depends on it!

- Dr. Doug Tallamy









Landscape Challenge 2012 Yau Family











Thank you to our past Board members
who continue to support our chapter
through ongoing memberships

❖ Scott Woodbury

❖ Susan Orr

❖ Pat Grace

❖ Larry Hummel

❖ Ana Grace Schactman

❖ Ed Schmidt

❖ Betty Struckhoff

❖ Nancy Zander

❖ Bill Bennett

❖ Bill Hoss

❖ Linda Bennett

❖ Wes Boshart











2015 Landscape Challenge – Rosalie Uchanski and Terry Egan

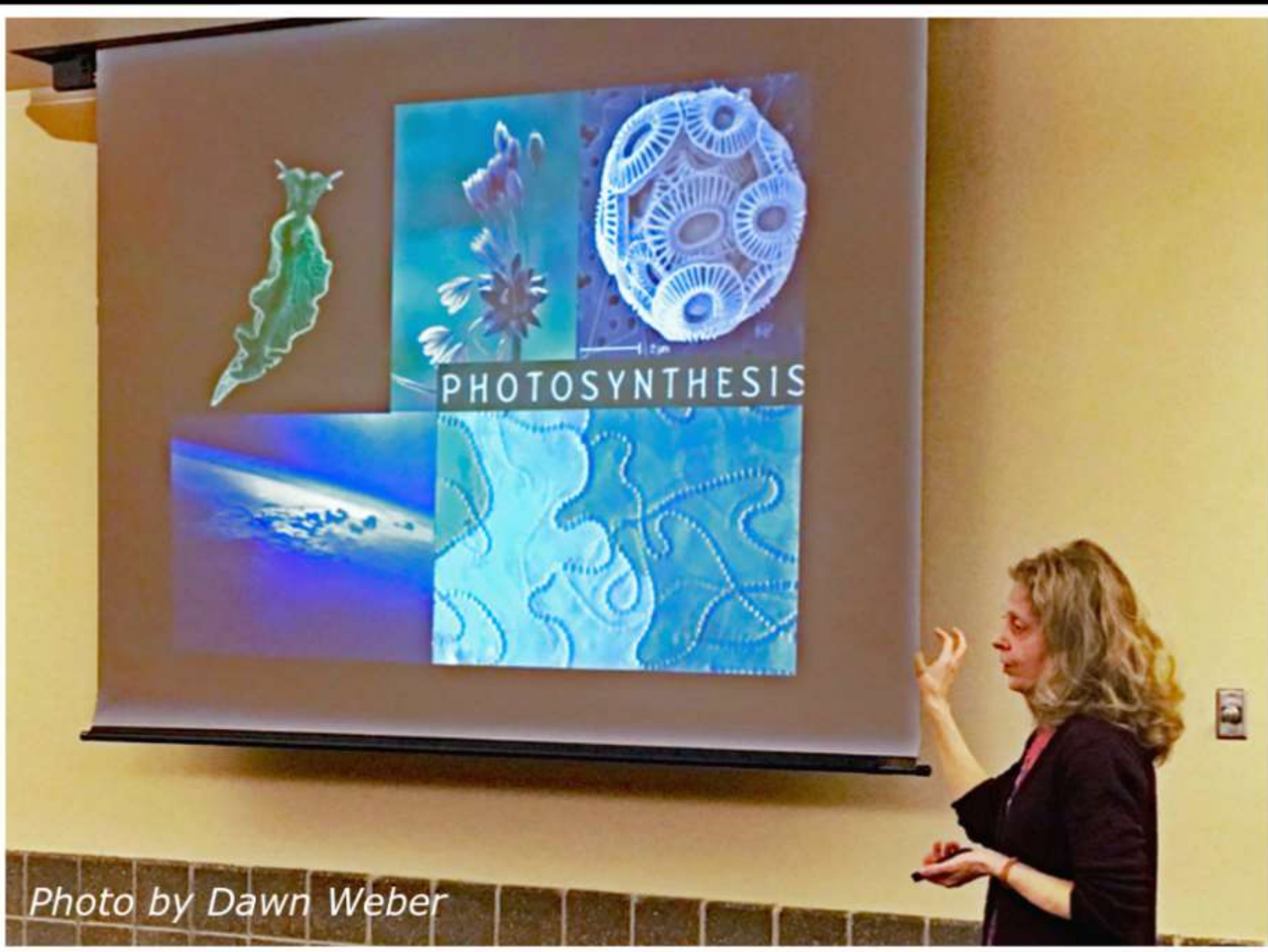

Photo by Dawn Weber



*Did you know?
Wild Ones across the US*



*55 Chapters
3700 members*

















Did you know?



In 2018 our Chapter
gave 9 grants to schools
and other nonprofits
totaling \$2835













2014 Landscape Challenge – Lisa Wilhelms





2016 St. Louis Nature Plant Garden Tour

A BIG thank you to our
20th Anniversary Planning Committee

Prem Barton

Pat Borgwald

Susan Burk

Susan Orr

Linda Tatum















2017 Landscape Challenge – Marlene Becker



Did you know?



*Our Chapter participated in
22 tabling events this year*

*Next year, help us spread
the news about Wild Ones*



















You can do wonderful things on
your own property to
protect the environment

Each little island, each corridor
will help bring back
the butterflies and birds

-Lorrie Otto









2018 Landscape Challenge – Dan Pearson



Kathy Bildner



Back

Blue Indigo
36" May/June

Prairie Bergamot
36" June/July

Swamp Milkweed
48" Aug/Sept

Purple Coneflower
36" June/August

Slender Mountain Mint
24" July/August

Aromatic aster
24" Oct/Nov

Liatris spicata
24" May/June

Cliff goldenrod
24" Sept/Oct

Butterfly Milkweed
24" June/July

Thread leaf bluestem
20" April/May

Front



Did you know?

Largest Chapters by Members

215 - Rock River Valley Chapter, IL

205 - Tennessee Valley Chapter, TN, GA, AL

201 - Fox Valley Chapter, WI

180 - St. Louis Chapter, MO















ALDO LEOPOLD BENCH

1993 VERSION — STATE FAIR PARK, DNR AREA.
MADE BY CARPENTERS AT THE ICE AGE
RESERVE. SAME MEASUREMENTS & PLAN,
EXCEPT: CLEAR WHITE CEDAR

- ANGLE OFF THE SEAT'S
FRONT CORNERS (DETAIL #1)*

- DRAFT A SIMILAR
ANGLE ON THE
UPPER FRONT
CORNERS OF THE
LONGER LEGS (DET #2)

- IF YOU WANT SOME
OF THE EDGES
ROUNDED OVER,
DECIDE BEFORE
ASSEMBLY. EITHER
EDGES A, B, C & D, OR
EDGE A & C.
ROUT WITH A $\frac{1}{4}$ " OR $\frac{3}{8}$ "
ROUNDING-OVER BIT.

- WOODBURN, ROUT OR STENCIL
NAME, LOGO OR QUOTE ON
BACK OR SEAT-EDGE.
(ARLYNE ACASC)

- WATCH FOR THAT LOOK
OF RECOGNITION WHEN
SOMEONE ROUNDS A
CORNER AND SPOTS YOUR
BENCH — (SIGN OF A
KINDRED SPIRIT)

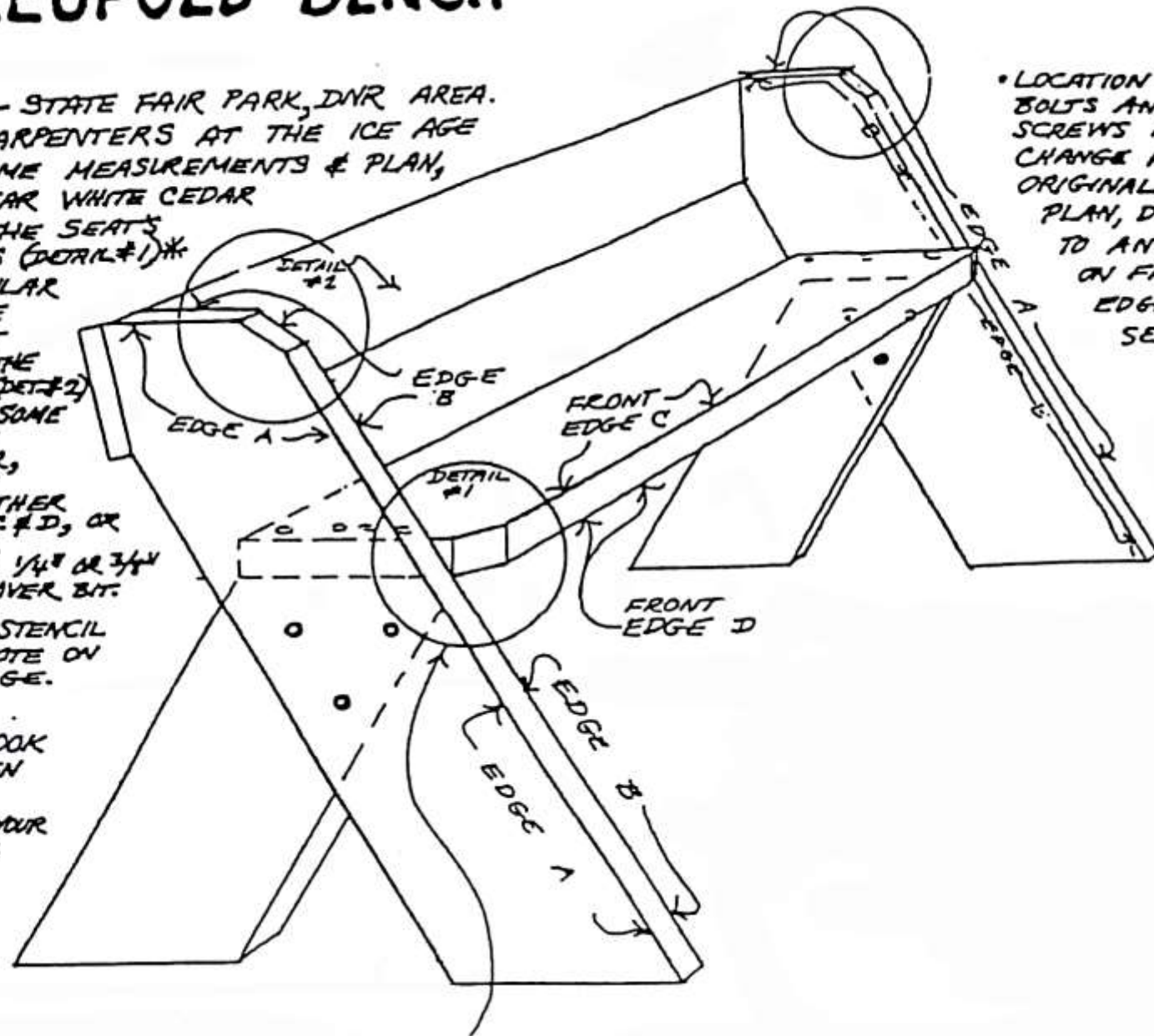

- LOCATION OF
BOLTS AND
SCREWS MAY
CHANGE FROM
ORIGINAL
PLAN, DUE
TO ANGLE.
ON FRONT
EDGE OR
SEAT.







© 2017 DAWN WEBER







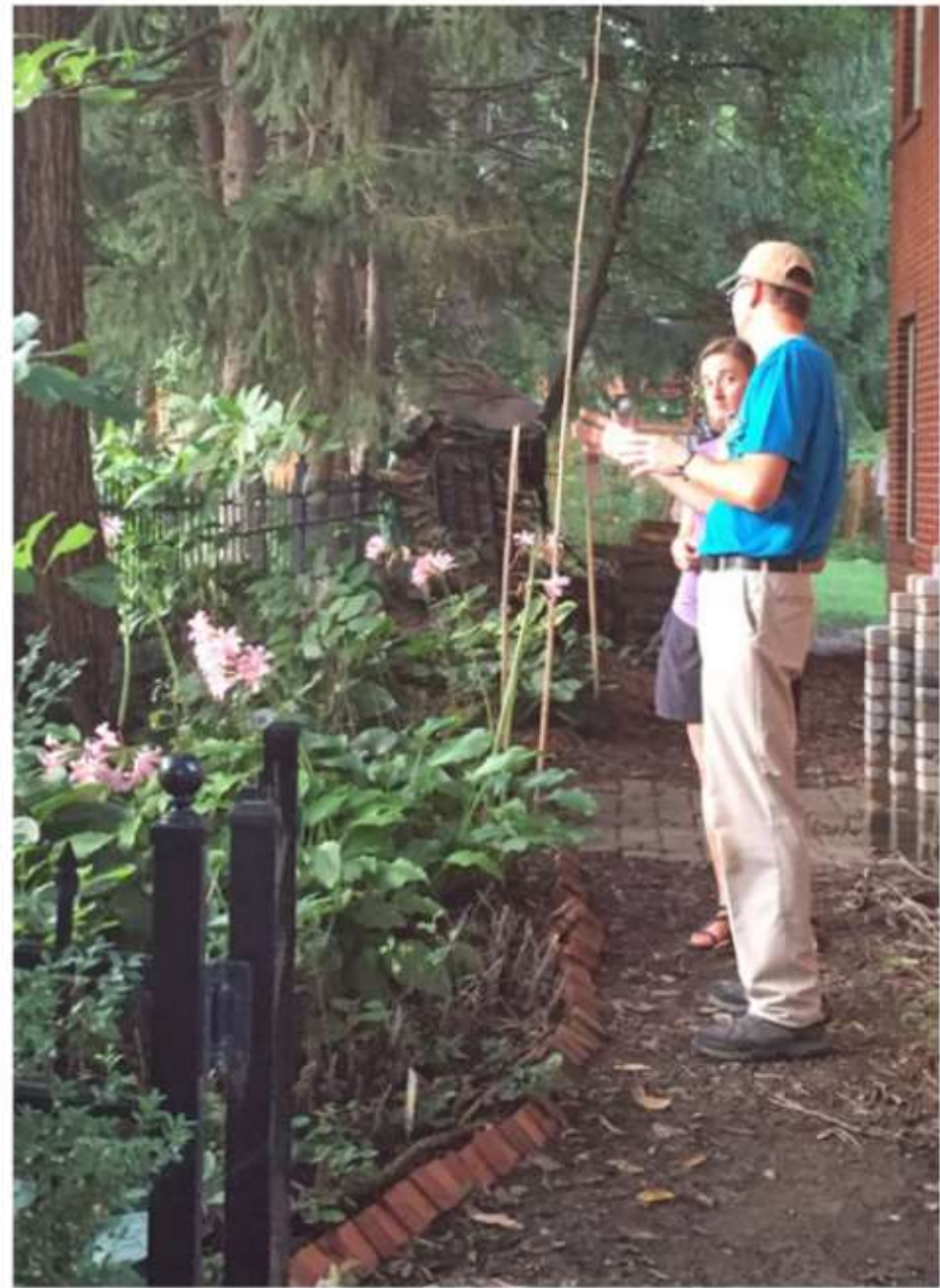

NATIVE MISSOURI
LANDSCAPE
for the Benefit of
Wildlife and People



www.stlwildones.org

*Do you have one of
our yard signs yet?*

The cost is only \$22

*Includes the stake and
mounting hardware*

*See Sue Leahy
to place your order*

©2018 Dawn Weber





MONARCH WAYSTATION



This site provides milkweeds, nectar sources, and shelter needed to sustain monarch butterflies as they migrate through North America.

Certified and registered by Monarch Watch as an official Monarch Waystation.

CREATE, CONSERVE, & PROTECT MONARCH HABITATS

www.MonarchWatch.org



© 2017 Dawn Weber



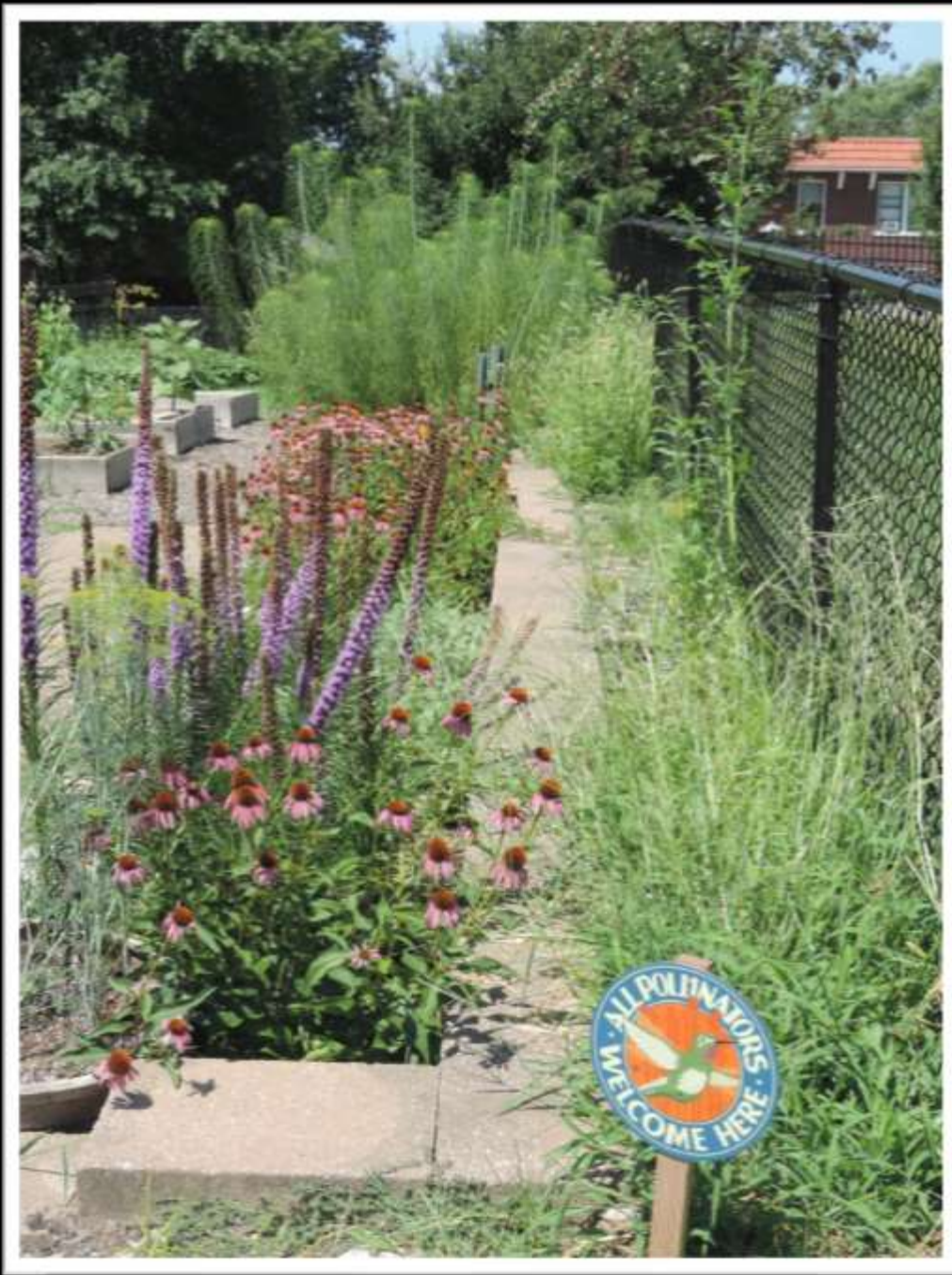





© 2015 Dawn Weber



Healing the Earth One Yard at a Time



Wild Ones

NATIVE PLANTS. NATURAL LANDSCAPES

ST. LOUIS CHAPTER

• For 20 Years •













